

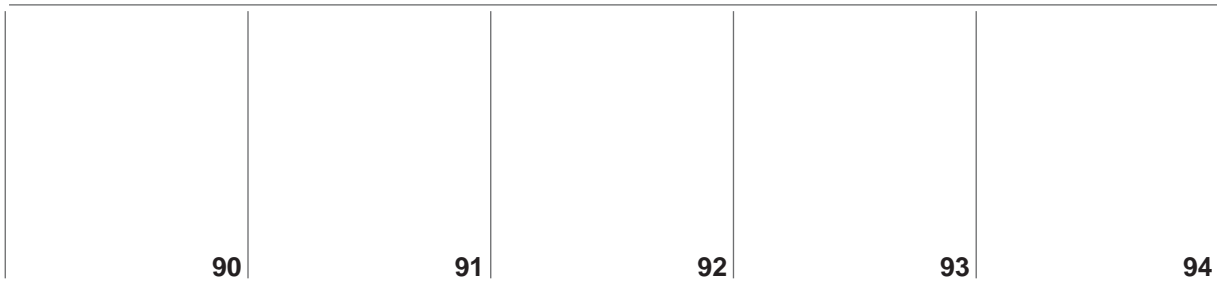

Accessori  
Accessories

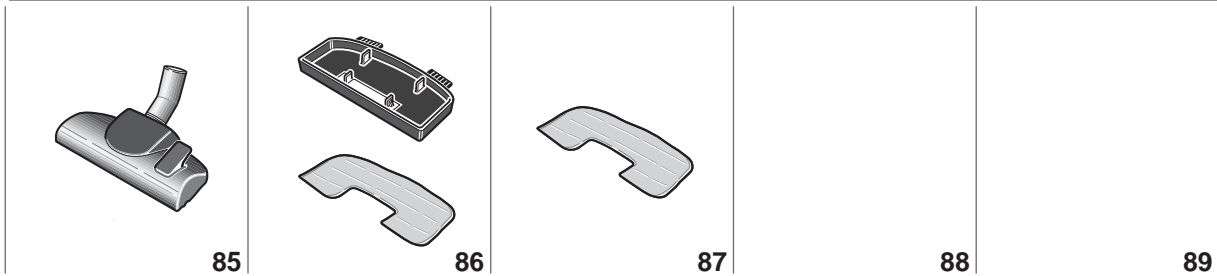

Accessori opzionali  
Optional accessories

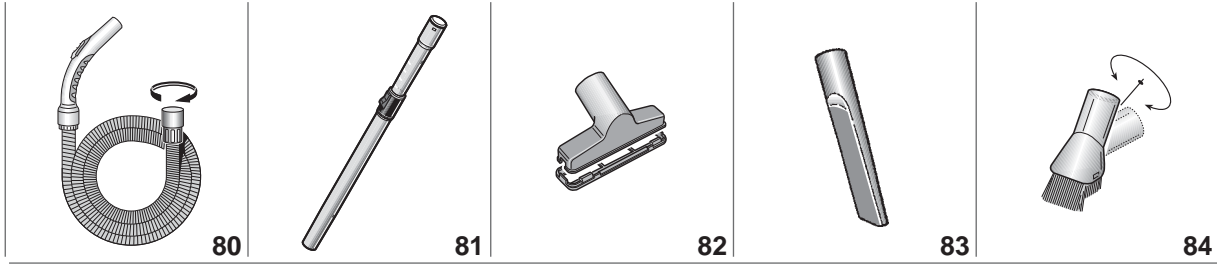
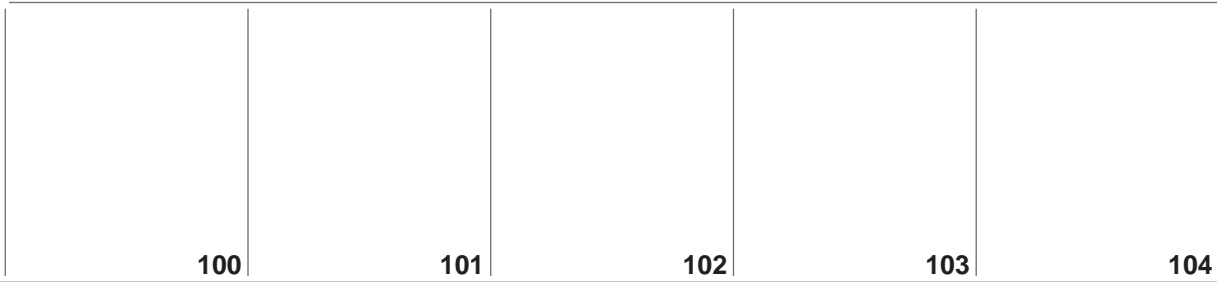
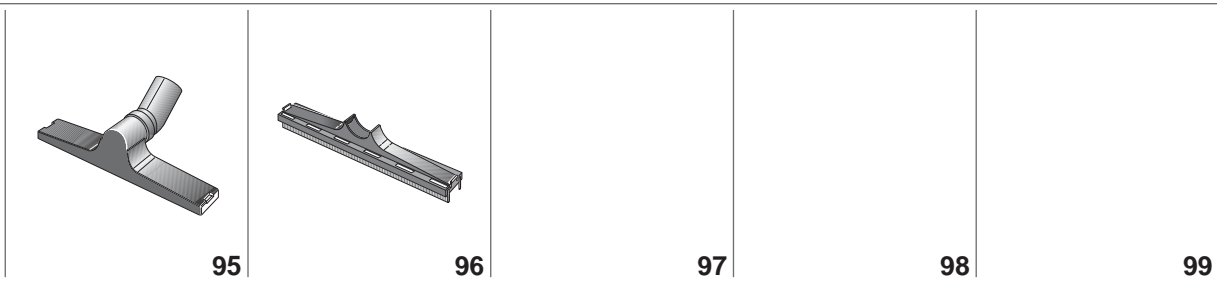

Sistemi filtranti  
Filter systems

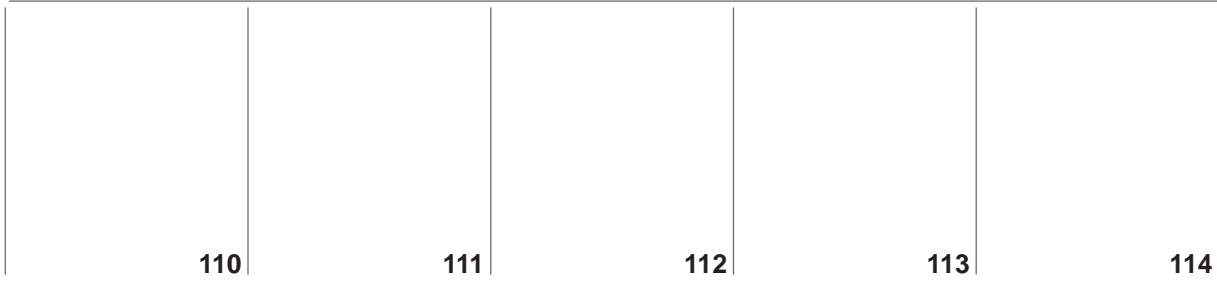
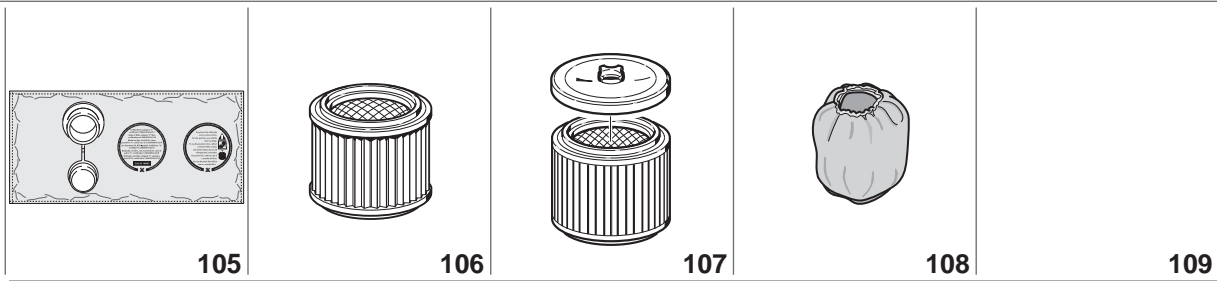



codice - code :  
97 608BFG

**PC 15 silent**

**Accessori - Accessories**

Pos.	Descrizione	Description	Codice Code	Prezzo unitario unit Price €
<b>Accessori</b>		<b>Accessories</b>		
80	Tubo flessibile ø 36 mm con manicotti girevoli e impugnatura ergonomica con deflussore	ø 36 mm flexible hose with swivelling connections and ergonomic grip with suction power reducer	01 304B0N	
81	Tubo di prolunga telescopico in alluminio ø 36 mm	ø 36 mm telescopic aluminum extension tube	40 039B0Z	
82	Bocchetta per imbottiti ø 36 mm	ø 36 mm upholstery nozzle	60 249B0N	
83	Bocchetta a lancia ø 36 mm	ø 36 mm crevice tool	60 250B0N	
84	Spazzola a pennello snodata con setole in crine ø 36 mm	Articulated ø 36 mm round brush with horsehair bristles	60 284B0N	
85	Spazzola combinata per pavimenti/moquette ø 36 mm	ø 36 mm combination brush for floors/carpets	60 287B0N	
86	Piastra con panno in microfibra alla spazzola combinata per pavimenti duri e in legno	Plate with microfiber cloth for combination brush for hard floors and wooden floors	60 288B0N	
87	Confezione 4 mop per piastra spazzola combinata	Package of 4 mops for combination brush plate	83 405B0I	
<b>Accessori opzionali</b>		<b>Optional accessories</b>		
95	Telaio per spazzola combinata ø 36 mm	Frame for ø 36 mm combination brush	60 281B0N	
96	Inserto per gomme raccogliliquidi	Insert for liquid collection elements in rubber	60 278B0N	
<b>Sistemi filtranti</b>		<b>Filter systems</b>		
105	Confezione 5 sacchi orizzontali in fibra IFA cat. "L"	Package of 5 IFA filter bags, fiber, category "L"	83 140BFI	
106	Confezione cartuccia filtro piccola IFA cat. "M"	Package of small IFA filter cartridge, category "M"	83 200BJA	
107	Confezione cartuccia filtro piccola IFA cat. "M" con disco adattatore	Package containing small IFA filter cartridge, category "M" with adapter disk	83 201BJA	
108	Filtro-mousse supporto motore	Foam filter on motor support	83 035BHB	

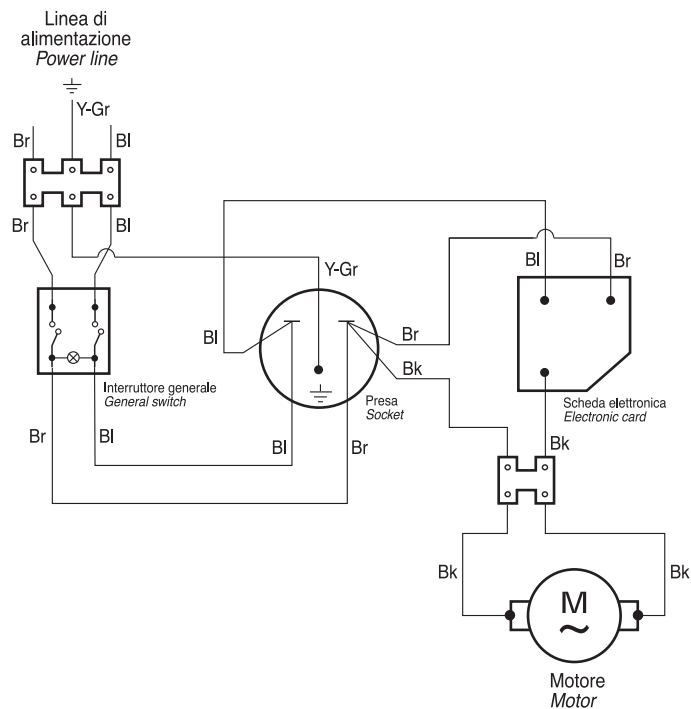

**Schema elettrico  
Electrical diagram**

Legenda colore cavi Cables colour coding	W - Bianco / White	Br - Marrone / Brown	Y - Giallo / Yellow
	Bk - Nero / Black	BI - Blu / Blue	
	R - Rosso / Red	Gr - Verde / Green	
			* - con faston - with faston